

ST9830 Quick Reference Guide

Quick Reference

Loading paper

Loading the 250- or 550-sheet tray

CAUTION—POTENTIAL INJURY: To reduce the risk of equipment instability, load each tray separately. Keep all other trays closed until needed.

1 Remove the tray.

Note: To avoid paper jams, do not remove trays while the printer is busy.



2 Adjust the guides to match the size of the paper that you are loading.

Note: Use the indicators on the bottom of the tray to position the guides.

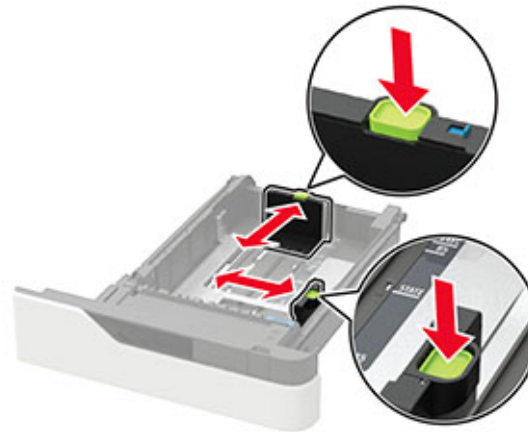
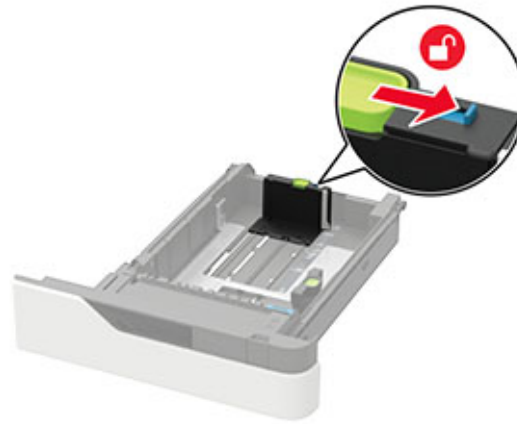

3 Flex, fan, and align the paper edges before loading.



4 Load the paper stack with the printable side facedown, and then make sure that the side guides fit snugly against the paper.



- Do not slide paper into the tray.
- To avoid paper jams, make sure that the stack height is below the maximum paper fill indicator.



- Load letterhead depending on whether an optional staple finisher is installed or not.

Without an optional staple finisher	With an optional staple finisher
 One-sided printing	 One-sided printing

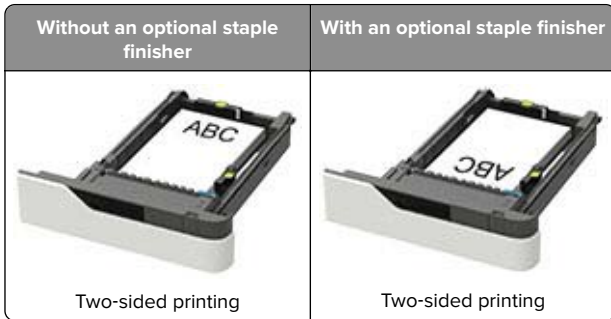

- When loading prepunched paper, make sure that the holes on the long edge of the paper are against the right side of the tray.

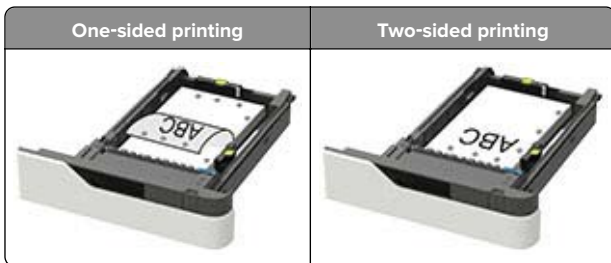

- Load envelopes with the flap side up and against the left side of the tray.



Warning—Potential Damage: Do not use envelopes with stamps, clasps, snaps, windows, coated linings, or self-stick adhesives.

- 5 Insert the tray.
- 6 From the control panel, set the paper size and paper type to match the paper loaded.

Loading the 2100-sheet tray

CAUTION—TIPPING HAZARD: To reduce the risk of equipment instability, load each tray separately. Keep all other trays closed until needed.

- 1 Pull out the tray.
- 2 Adjust the guides.

Loading A5-size paper

- a Pull up and slide the width guide to the position for A5.



- b Squeeze and slide the length guide to the position for A5 until it *clicks* into place.

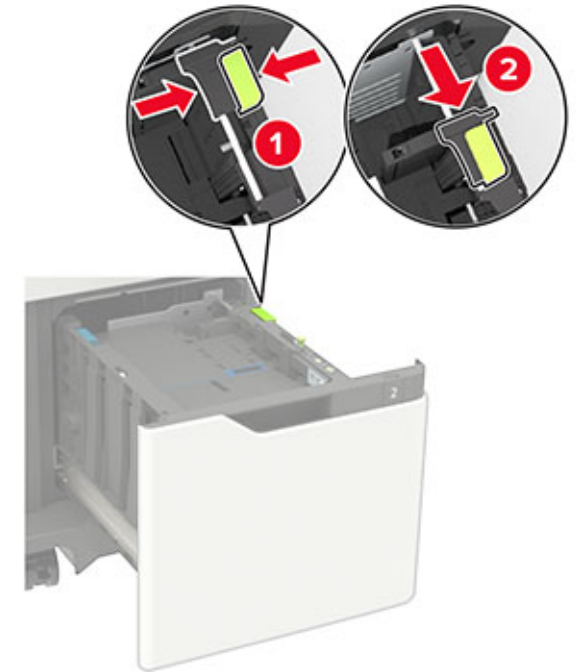

- c Remove the A5 length guide from its holder.

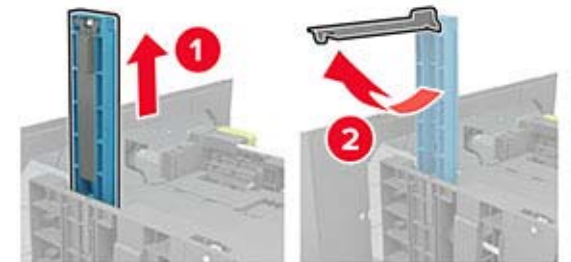

- d** Insert the guide into its designated slot, and then press until it *clicks* into place.

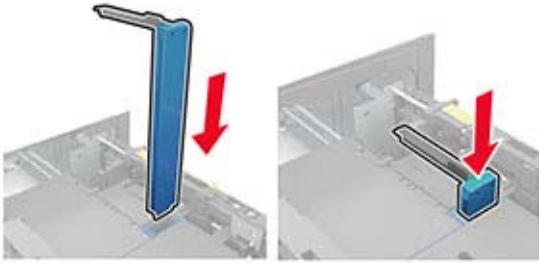

Loading A4-, letter-, legal-, Oficio-, and folio-size paper

- a** Pull up and slide the width guide to the correct position for the size of the paper being loaded.



- b** If the A5 length guide is still attached, then remove it. If the guide is not attached, then proceed to [step d on page 3](#).

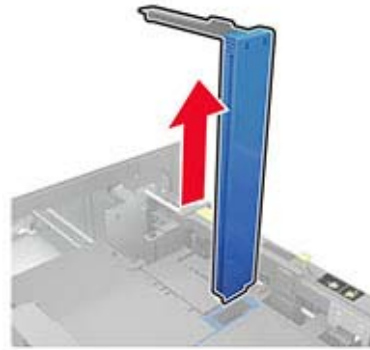

- c** Place the A5 length guide in its holder.

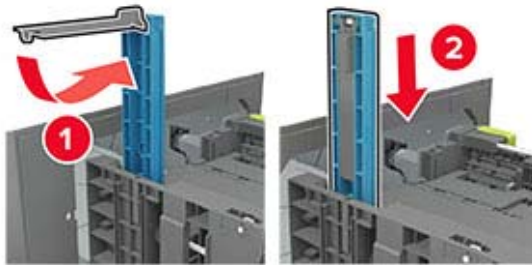

- d** Squeeze, and then slide the length guide to the correct position for the size of the paper being loaded.



- 3** Flex, fan, and align the paper edges before loading.



- 4** Load the paper stack with the printable side facedown.
- Load letterhead depending on whether an optional staple finisher is installed or not.



- When loading prepunched paper, make sure that the holes on the long edge of the paper are against the right side of the tray.

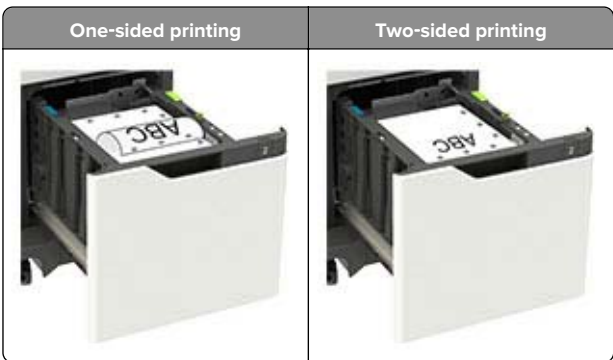

5 Insert the tray.

Note: Press down the paper stack while inserting the tray.

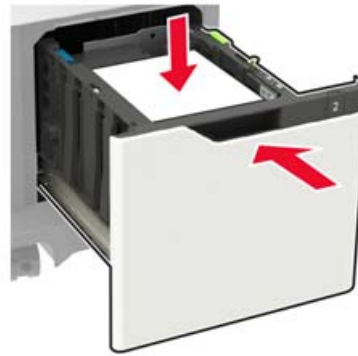

6 From the control panel, set the paper size and paper type to match the paper loaded.

Loading the multipurpose feeder

1 Open the multipurpose feeder.



2 Adjust the guide to match the size of the paper that you are loading.



3 Flex, fan, and align the paper edges before loading.



4 Load paper with the printable side faceup.

- Load letterhead depending on whether an optional staple finisher is installed or not.

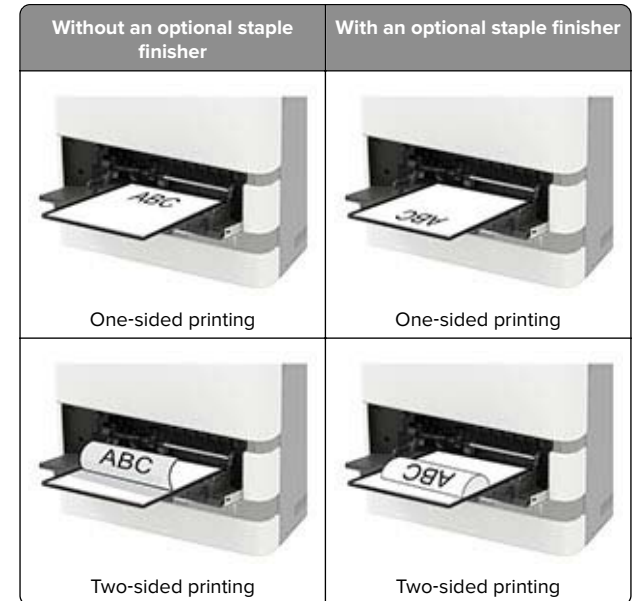

- When loading prepunched paper, make sure that the holes on the long edge of the paper are against the right side of the paper guide.

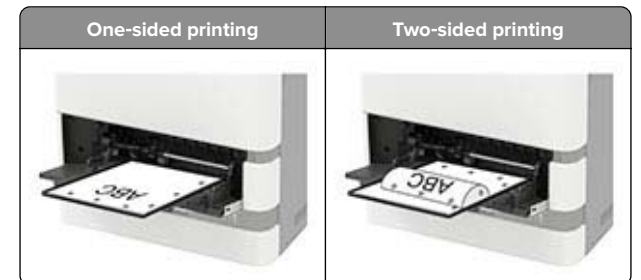

- Load envelopes with the flap side down and against the left side of the paper guide.

Warning—Potential Damage: Do not use envelopes with stamps, clasps, snaps, windows, coated linings, or self-stick adhesives.

- 5 From the control panel, set the paper size and paper type to match the paper loaded.

Setting the paper size and type

- 1 From the control panel, navigate to:
Settings > Paper > Tray Configuration > Paper Size/Type > select a paper source

For non-touch-screen printer models, press  to navigate through the settings.

- 2 Set the paper size and type.

Printing

Printing from a computer

Note: For labels, card stock, and envelopes, set the paper size and type in the printer before printing the document.

- 1 From the document that you are trying to print, open the Print dialog.
- 2 If necessary, adjust the settings.
- 3 Print the document.

Printing confidential and other held jobs

For Windows users

- 1 With a document open, click **File > Print**.
- 2 Click **Properties, Preferences, Options, or Setup**.
- 3 Click **Print and Hold**.
- 4 Select **Use Print and Hold**, and then assign a user name.

- 5 Select the print job type (Confidential, Repeat, Reserve, or Verify).

If the print job is confidential, then enter a four-digit PIN.

- 6 Click **OK** or **Print**.

- 7 From the printer home screen, release the print job.

- For confidential print jobs, navigate to:
Held jobs > select your user name > Confidential > enter the PIN > select the print job > configure the settings > Print
- For other print jobs, navigate to:
Held jobs > select your user name > select the print job > configure the settings > Print

For Macintosh users

- 1 With a document open, choose **File > Print**.

If necessary, click the disclosure triangle to see more options.

- 2 From the print options or Copies & Pages menu, choose **Job Routing**.

- 3 Select the print job type (Confidential, Repeat, Reserve, or Verify).

If the print job is confidential, then assign a user name and a four-digit PIN.

- 4 Click **OK** or **Print**.

- 5 From the printer home screen, release the print job.

- For confidential print jobs, navigate to:
Held jobs > select your user name > Confidential > enter the PIN > select the print job > configure the settings > Print
- For other print jobs, navigate to:
Held jobs > select your user name > select the print job > configure the settings > Print

Maintaining the printer

Replacing the toner cartridge

- 1 Open door A.

Warning—Potential Damage: To prevent damage from electrostatic discharge, touch any exposed metal frame of the printer before accessing or touching interior areas of the printer.



- 2 Remove the used toner cartridge.



- 3 Unpack the new toner cartridge, and then shake it to redistribute the toner.

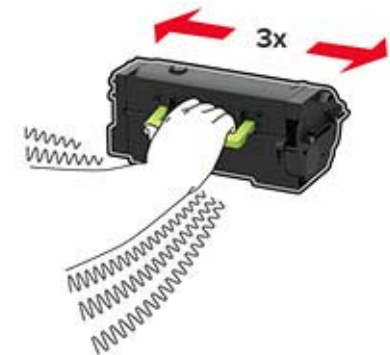

- 4 Insert the new toner cartridge.



- 5 Close the door.

Clearing jams

Avoiding jams

Load paper properly

- Make sure paper lies flat in the tray.

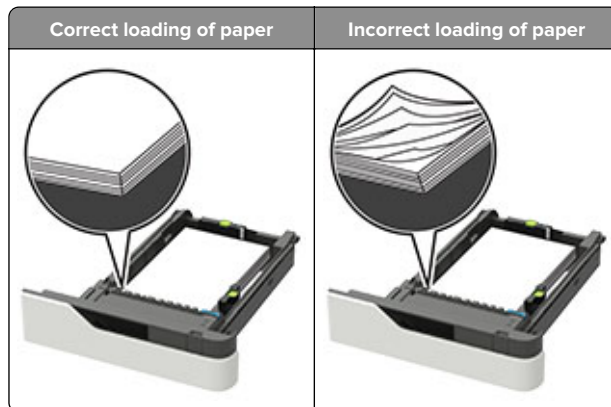

- Do not remove a tray while the printer is printing.
- Do not load a tray while the printer is printing. Load it before printing, or wait for a prompt to load it.

- Do not load too much paper. Make sure the stack height is below the maximum paper fill indicator.
- Do not slide the paper into the tray. Load paper as shown in the illustration.

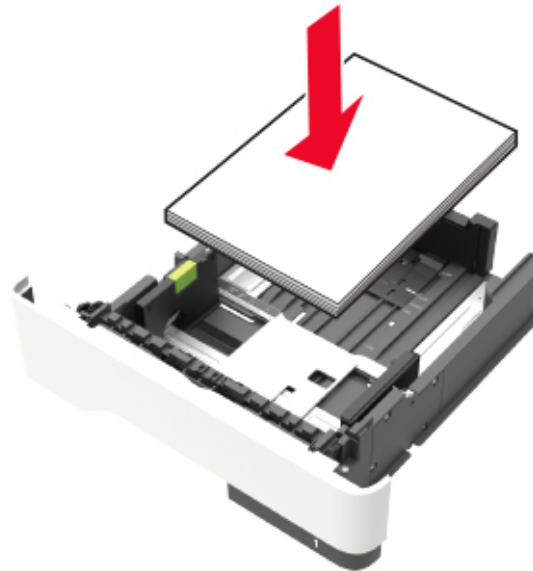

- Make sure the guides in the tray or the multipurpose feeder are properly positioned and are not pressing tightly against the paper or envelopes.
- Push the tray firmly into the printer after loading paper.
- If you are loading prepunched paper for use with the staple finisher, then make sure the holes on the long edge of the paper are on the right side of the tray. For more information, see the "Loading paper and specialty media" section of the *User's Guide*.

Allow the paper to enter the optional mailbox bins properly

- Make sure to adjust the bin extender so that the paper size indicators match the size of the paper used.

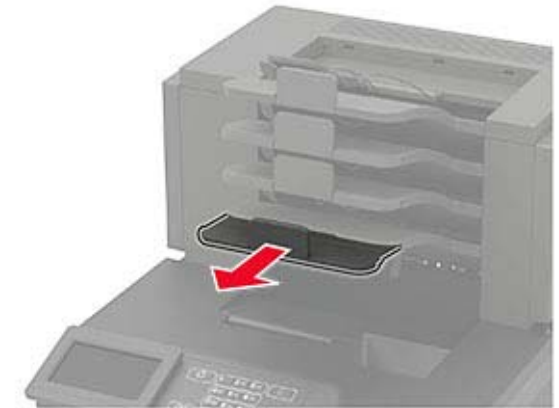

Notes:

- If the bin extender is shorter than the size of the paper you are printing on, then the paper causes a jam in the mailbox bin. For example, if you are printing on a legal-size paper and the bin extender is set to letter-size, then a jam occurs.
- If the bin extender is longer than the size of the paper you are printing on, then the edges become uneven and the paper is not stacked properly. For example, if you are printing on a letter-size paper and the bin extender is set to legal-size, then the paper does not stack properly.

- If paper needs to be returned to the mailbox bin, then insert the paper under the bin arm, and then push the paper all the way back.

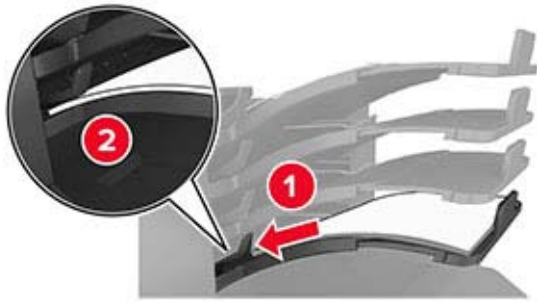

Note: If the paper is not under the bin arm, then a jam occurs due to an overfilled bin.

Use recommended paper

- Use only recommended paper or specialty media.
- Do not load wrinkled, creased, damp, bent, or curled paper.
- Flex, fan, and straighten paper or specialty media before loading it.



- Do not use paper that has been cut or trimmed by hand.
- Do not mix paper sizes, weights, or types in the same tray.
- Make sure the paper size and type are set correctly on the computer or printer control panel.
- Store paper per manufacturer recommendations.

Identifying jam locations

Notes:

- When Jam Assist is set to On, the printer flushes blank pages or pages with partial prints after a jammed page has been cleared. Check your printed output for blank pages.

- When Jam Recovery is set to On or Auto, the printer reprints jammed pages.

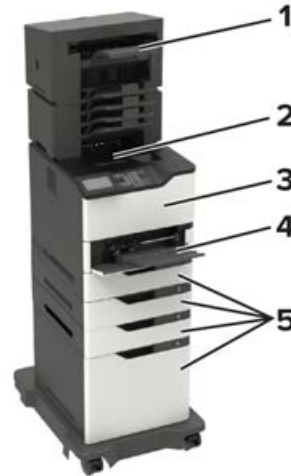

Jam locations	
1	Finisher or output option bin
2	Standard bin
3	Door A
4	Multipurpose feeder
5	Trays

Jam locations	
6	Finisher or output option rear door <ul style="list-style-type: none"> • Door H • Door K • Door L • Door N • Door P
7	Door C
8	Stapler door <ul style="list-style-type: none"> • Door F • Door G

Paper jam in trays

- 1 Remove the tray.



- 2 Remove the jammed paper.

Note: Make sure that all paper fragments are removed.



3 Insert the tray.

Paper jam in door A

1 Open door A.

Warning—Potential Damage: To prevent damage from electrostatic discharge, touch any exposed metal frame of the printer before accessing or touching interior areas of the printer.



2 Remove the toner cartridge.



3 Remove the imaging unit.



Warning—Potential Damage: Do not expose the imaging unit to direct light for more than 10 minutes. Extended exposure to light may cause print quality problems.

Warning—Potential Damage: Do not touch the photoconductor drum. Doing so may affect the quality of future print jobs.



4 Pull out the duplex unit.



5 Remove the jammed paper.

Note: Make sure that all paper fragments are removed.



- 6 Insert the duplex unit.
- 7 Insert the imaging unit.



- 8 Insert the toner cartridge.



- 9 Close the door.

Paper jam in door C

- 1 Open door C.

 **CAUTION—HOT SURFACE:** The inside of the printer might be hot. To reduce the risk of injury from a hot component, allow the surface to cool before touching it.

Warning—Potential Damage: To prevent damage from electrostatic discharge, touch any exposed metal frame of the printer before accessing or touching interior areas of the printer.



- 2 Remove the jammed paper from any of the following areas:

Note: Make sure that all paper fragments are removed.

- Fuser area



- Below the fuser area



- Duplex area



- 3 Close the door.

Paper jam in the standard bin

Remove the jammed paper.

Note: Make sure that all paper fragments are removed.



Paper jam in the multipurpose feeder

- 1 Remove paper from the multipurpose feeder.



- 2 Remove the jammed paper.

Note: Make sure that all paper fragments are removed.

- 3 Flex, fan, and align the paper edges before loading.



- 4 Reload paper.



Paper jam in the output expander

- 1 Open door K.

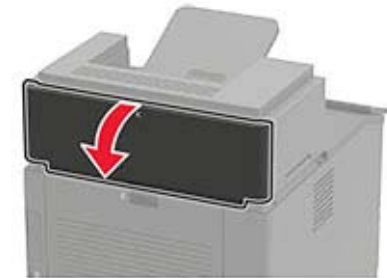

- 2 Remove the jammed paper.

Note: Make sure that all paper fragments are removed.



- 3 Close the door.

Paper jam in the high-capacity output expander

- 1 Open door L.

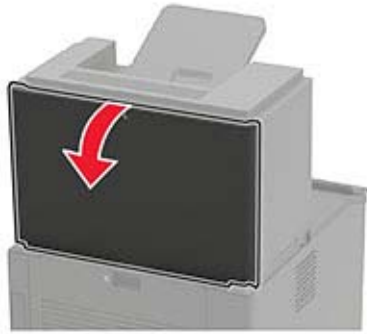

- 2 Remove the jammed paper.

Note: Make sure that all paper fragments are removed.



- 3 Close the door.

Paper jam in the 4-bin mailbox

Paper jam in door N

- 1 Open door N.

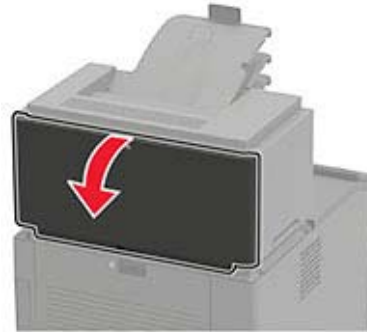

- 2 Remove the jammed paper.

Note: Make sure that all paper fragments are removed.



- 3 Close the door.

Paper jam in the mailbox bin

Remove the jammed paper.

Note: Make sure that all paper fragments are removed.

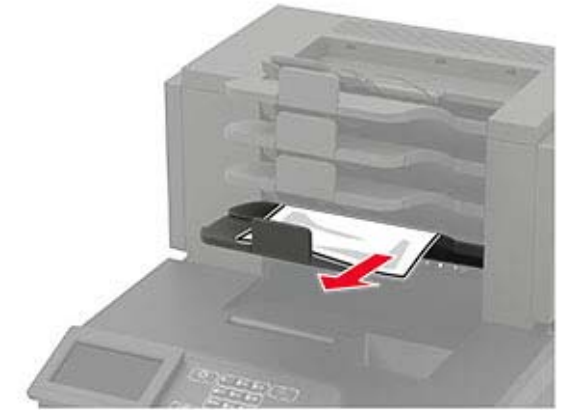

Paper jam in the staple finisher

Paper jam in door H

- 1 Open door H.

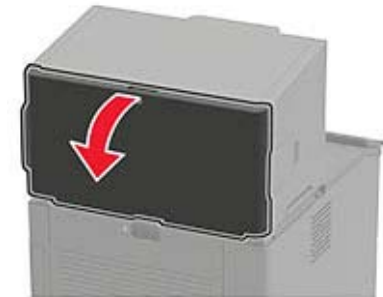

- 2 Remove the jammed paper.

Note: Make sure that all paper fragments are removed.



3 Close the door.

Paper jam in the staple finisher bin

Remove the jammed paper.

Note: Make sure that all paper fragments are removed.



Paper jam in the staple, hole punch finisher

Paper jam in door P

1 Open door P.

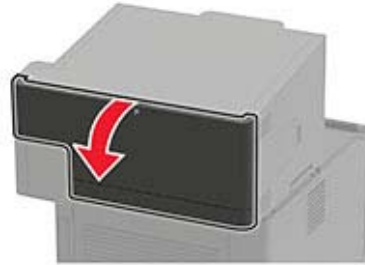

2 Remove the jammed paper.

Note: Make sure that all paper fragments are removed.



3 Close the door.

Paper jam in the staple, hole punch finisher bin

Remove the jammed paper.

Note: Make sure that all paper fragments are removed.



Staple jam in the staple finisher

1 Open door F.



2 Remove the staple cartridge holder.

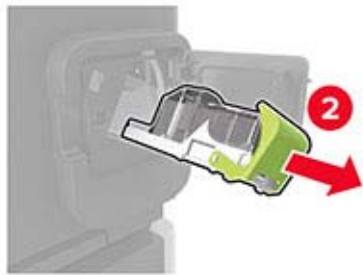
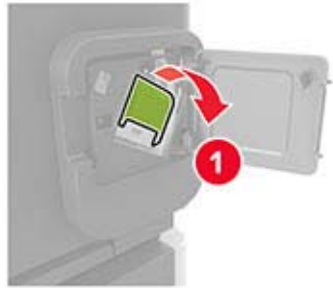

3 Remove the loose staples.

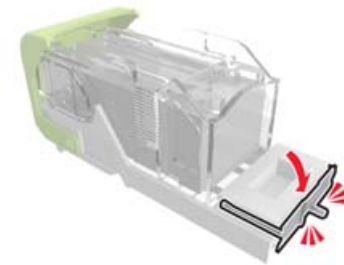
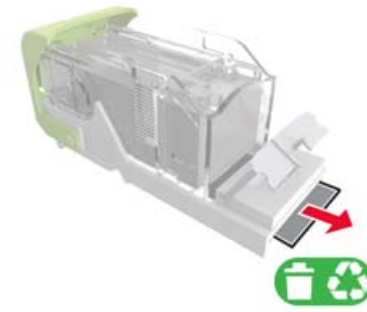

4 Press the staples against the metal bracket.



Note: If the staples are at the rear of the cartridge, then shake the cartridge downward to bring the staples near the metal bracket.



5 Insert the staple cartridge holder until it *clicks* into place.

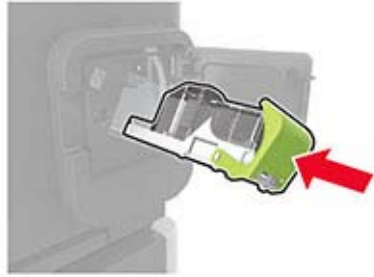

6 Close the door.

Staple jam in the staple, hole punch finisher

1 Depending on the staple jam location, open either door F or door G.



2 Remove the staple cartridge holder.

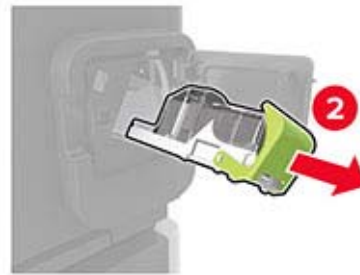

3 Remove the loose staples.

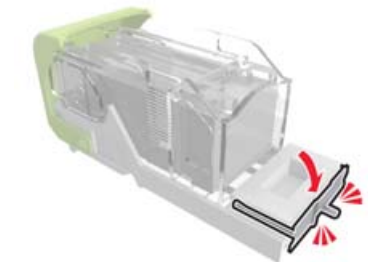
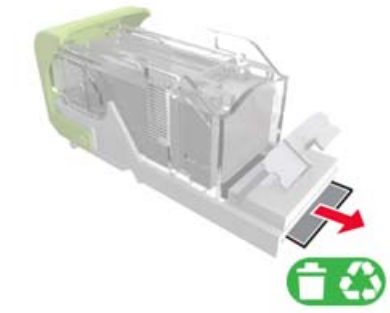

4 Press the staples against the metal bracket.



Note: If the staples are at the rear of the cartridge, then shake the cartridge downward to bring the staples near the metal bracket.

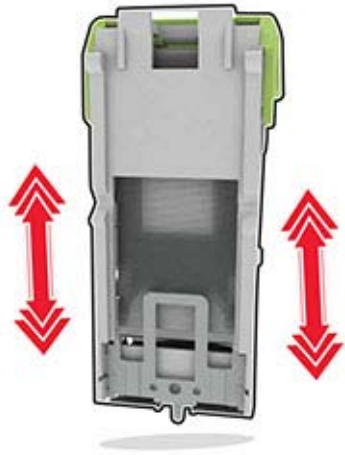

5 Insert the staple cartridge holder until it *clicks* into place.



6 Close the door.